

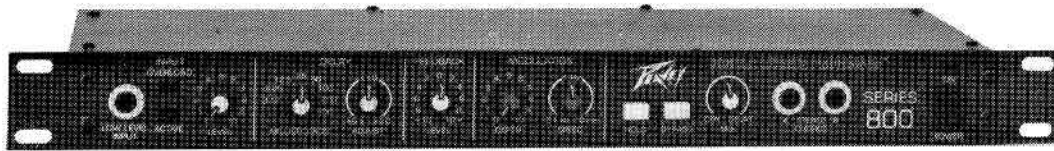

# DEP 800



## OPERATING GUIDE

**CAUTION**  
TO PREVENT ELECTRICAL SHOCK OR FIRE HAZARD, DO NOT EXPOSE THIS INSTRUMENT TO RAIN OR MOISTURE.  
BEFORE USING THIS INSTRUMENT, READ BACK COVER FOR FURTHER WARNINGS.

### CLASS B COMPUTING DEVICE: INFORMATION TO USER

This equipment generates and uses radio frequency energy and if not installed and used properly, that is, in accordance with the manufacturer's instructions, may cause interference to radio and television reception. It has been type tested and found to comply with the limits for a Class B computing device in accordance with the specifications in Subpart J of Part 15 of FCC Rules, which are designed to provide reasonable protection against such interference in a residential installation. However, there is no guarantee that interference will not occur in a particular installation. If this equipment does cause interference to radio or television reception, which can be determined by turning the equipment off and on, the user is encouraged to try to correct the interference by one or more of the following measures:

- reorient the receiving antenna
- relocate the equipment with respect to the receiver
- move the equipment away from the receiver
- plug the equipment into a different outlet so that the equipment and receiver are on different branch circuits.

If necessary, the user should consult the dealer or an experienced radio-television technician for additional suggestions. The user may find the following booklet prepared by the Federal Communications Commission helpful:

"How to Identify and Resolve Radio-TV Interference Problems"

This booklet is available from the US Government Printing Office, Washington, DC 20402, Stock No. 004-000-00345-4.

### INTRODUCTION

The Peavey Digital Effects Processor 800 utilizes advanced technology and unique implementation approaches to provide high performance digital audio processing in a unique affordable package. Its quality, performance and capabilities are defined specifically for the performing musician with no American Express Gold Card.

The DEP 800 System provides continuously adjustable delay settings from 3.12 milliseconds to 800 milliseconds (0.800 seconds) with the best possible signal quality. A full instrument bandwidth (20 Hz to 10 kHz) is available at all settings and with any of the effects enabled. This allows for utilization with a large number of musical instrument signal inputs where a higher bandwidth is not required.

By utilizing the extended range of delay settings, a wide range of digital effects including flanging, doubling, chorusing, and slap-back echo can be obtained through the front panel controls. The front panel controls allow for the addition of LFO modulation of the delay length, feedback or regeneration of the delayed signal, LFO modulation of the output signal frequency and total amplitude and phase control of both feedback and delayed signals.

The utilization of a 6th order Chebyshev Low Pass Filter for both anti-aliasing and for signal reconstruction minimizes distortion by providing excellent stop-band signal rejection.

This special signal processing implementation provides a wide variety of digital effects at an affordable price with excellent performance specifications.

---

## TABLE OF CONTENTS

---

I. Introduction .....	1
II. Processor Specifications .....	2
III. Processor Features .....	2
IV. Front Panel Description .....	3
V. Rear Panel Description .....	3 & 4
VI. Typical Effects Descriptions .....	4
VII. Block Diagram and Circuit Description .....	5 & 6

---

## SPECIFICATIONS

---

### DELAY RANGE

3.12 to 800 milliseconds

### DELAY ADJUST

0.5 (50%) to 2.0 (200%) of range

### FREQUENCY RESPONSE

20 Hz to 10 kHz @ all settings  
(+/- 1.0 dB)

### QUANTIZATION

8 Bits A/D & D/A Conversion  
Log Companding with Pre-Emphasis

### SAMPLE RATE

Variable Conversion Rate  
(Varies w/Modulation and Delay)

### ANTI-ALIASING FILTER

10 kHz 6-pole Chebyshev Low Pass Filter —  
36 dB/Octave minimum roll-off

### SIGNAL-TO-NOISE

48 dB minimum delay  
90 dB minimum dry

### DYNAMIC RANGE

90 dB minimum delay  
90 dB minimum dry

### INPUTS

#### Low Level

0.25 Vrms, -12 dBV (Front Panel)

#### Line Level

2.0 Vrms, +6 dBV (Rear Panel)

### OUTPUTS

#### Low Level Stereo

0.25 Vrms, -12 dBV (Front Panel)

#### Line Level Stereo

2.0 Vrms, +6 dBV (Rear Panel)

### HEADROOM

#### Active

+6 dB reserve

#### Overload

+3 dB reserve

### VCO MODULATION

Complete control of the  
LFO modulation of the internal VCO

### LFO Depth Range

Up to 4:1

### LFO Frequency

0.1 Hz to 10 Hz

### LFO Waveshape

Triangle Wave w/variable amplitude

### HOLD

Replays signal in memory  
indefinitely without degradation

### FEEDBACK

Allows feedback of delayed signal  
for multiple echos or for effects

### FOOTSWITCH

Bypass

Hold

### MODULATION

Input for Modulation of VCO

---

## FEATURES

---

- \* Continuously variable delay time from 3.12 milliseconds to 800 milliseconds (0.800 seconds) with 8 operating ranges.
- \* 20 Hz to 10 kHz bandwidth at all delay settings and with any special effects active.
- \* Easily controlled Low Frequency Oscillator (LFO) with continuously variable frequency and depth for modulation of effects.
- \* Wide range of special effects including:
  - Flanging
  - Chorusing
  - Doubling
  - Slapback Echo
  - Vibrato
  - Long Delay
- \* Hold switch with optional footswitch control for infinite repeat without signal degradation.
- \* Low Level and Line Level inputs and outputs for ease of use in a multitude of operational environments.
- \* Dual-phase (+/-) processing of feedback and delay output signals.
- \* Stereo Chorus outputs with dry/delay mix control
- \* Bypass switch with optional footswitch control
- \* External Effects modulation inputs for VCO control.

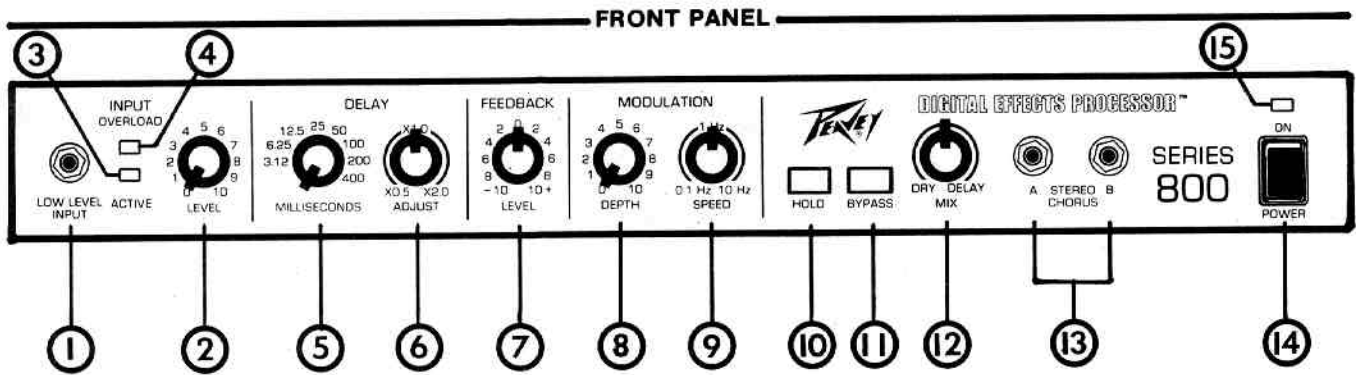

### INPUT SECTION

- (1) Low Level Input - Musical instrument input jack set for a nominal input level of 250 millivolts (-12 dBV).
- (2) Input Level Control - Gain control for the input section of the Digital Effects Processor. Used to maximize the signal-to-noise ratio of the unit. Should be adjusted such that the Overload indicator just begins to light.
- (3) Active Indicator - Indicates that the processor input level is sufficient for adequate operation.
- (4) Overload Indicator - Indicates when the processor has only 3 dB of headroom left available. Continuous illumination of the Red LED indicates that the unit is being overdriven and distortion could result.

### DELAY SECTION

- (5) Range Select - Switch selection of the desired delay memory range. Range Number indicates the amount of delay (in milliseconds) available with the Delay Adjust control set at 12 o'clock.
- (6) Delay Adjust - Varies the amount of delay from 0.5 (50%) to 2.0 (200%) of the selected delay range. Also varies the maximum amount of modulation achievable on a particular range.

### REGENERATION SECTION

- (7) Feedback Level - Controls the amount of feedback signal and thus the amount of regeneration accomplished. Also controls the phase of the feedback signal. No feedback is generated with the control set at 12 o'clock. Rotation in a CCW direction increases the negative phase while rotation in a CW direction increases the positive phase feedback.

### MODULATION SECTION

- (8) LFO Depth - Controls the modulation depth or the maximum or minimum delay length. Maximum achievable range varies with the Delay Adjust setting but can be as much as 4-to-1.
- (9) LFO Speed - Controls the LFO Modulation frequency from approximately 0.1 Hz to 10.0 Hz.

### OUTPUT SECTION

- (10) Hold - Provides an infinite repeat of the signal stored in memory without degradation. Footswitch control option.
- (11) Bypass - Allows the bypass of the Digital Effects Processor regardless of any settings. Footswitch control option.
- (12) Output Mix - Provides the control of the mix of the dry and the delayed signal. Both in-phase and out-of-phase signals (Stereo Chorus A output and B output) are controlled simultaneously. Output signal can be varied from only "dry" (no delay) signal to only delayed signal. Output level is nominally -12 dBV or 0.25 Vrms.
- (13) Stereo Chorus Output - Provides simultaneous outputs for both in-phase and out-of-phase delayed signal mixed with the original "dry" signal. Mix is controlled with the Output Mix Control.
- (14) Power Switch - Used to turn on the unit. Enables the A.C. power for both the +/-15 volt supply and the +5 volt supply.
- (15) Power On Indicator - Indicates that the power has been applied to the unit. Power should be turned off before plugging in the unit or removing the plug from the A.C. source.

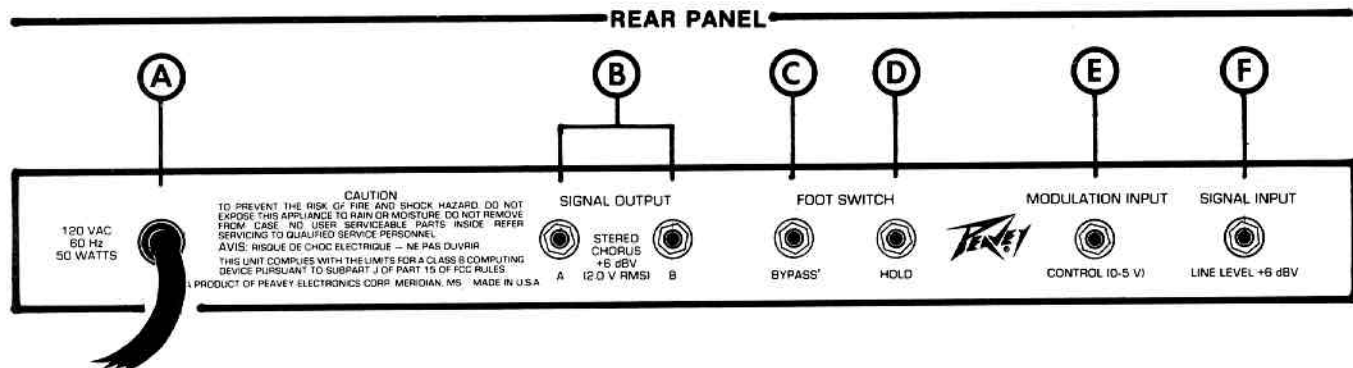

### OUTPUT SECTION

- (A) A.C. Line Cable - Used to supply 120 volt, 60 Hz A.C.\* mains power to the unit. Should be plugged into any standard 120 wall outlet or equivalent.  
\* (Export models utilize 220-240 volt A.C./50 Hz power supplies with appropriate main plug and cable assembly.)
- (B) Stereo Chorus Line Level Output - Line level output jack to provide signal levels of 2.0 Vrms (+6 dBV) as an output. Can be used in conjunction with the front panel jacks.

## FOOTSWITCH SECTION

- (C) Bypass Switch - Remote control of the Bypass function.
- (D) Hold Switch - Remote control of the infinite Hold function.
- (E) Modulation Control - External modulation input control.

## INPUT SECTION

- (F) Line Level Input - Line level input jack to accommodate a 2.0 Vrms (+6 dBV) level signal input. When used, the front panel jack is disabled.

## TYPICAL EFFECTS DESCRIPTIONS

Shaded regions indicate areas of activation

### Comb Filtering

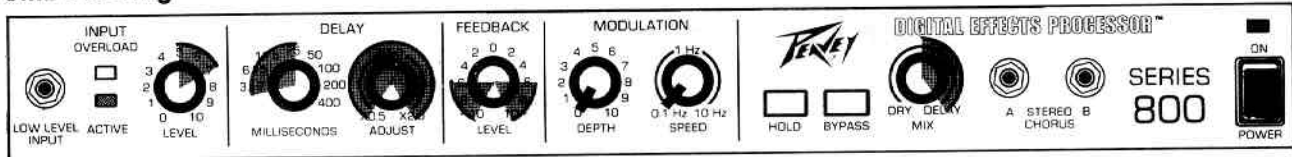

### Flanging

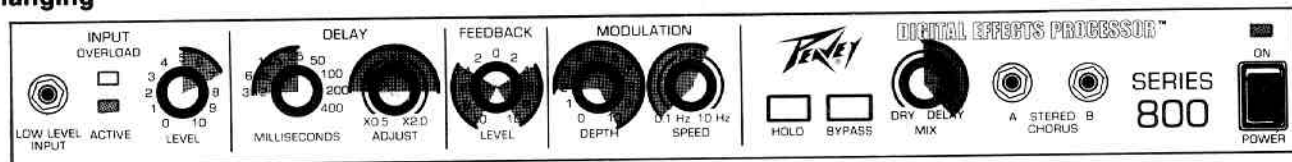

### Chorus

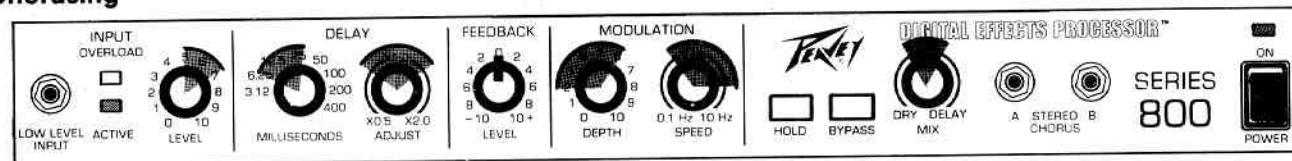

### Doubling

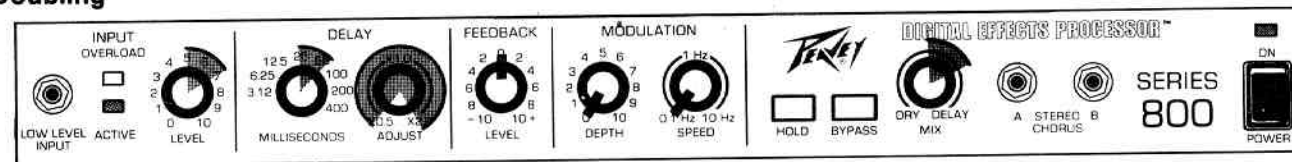

### Slapback Echo

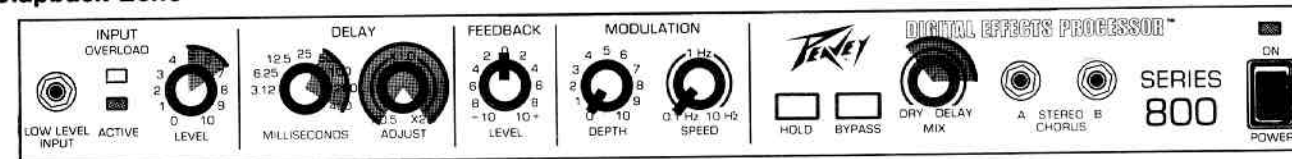

### Long Delay - Single or Multiple Repeats

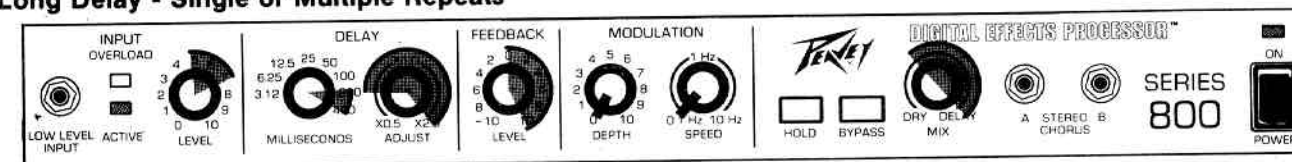

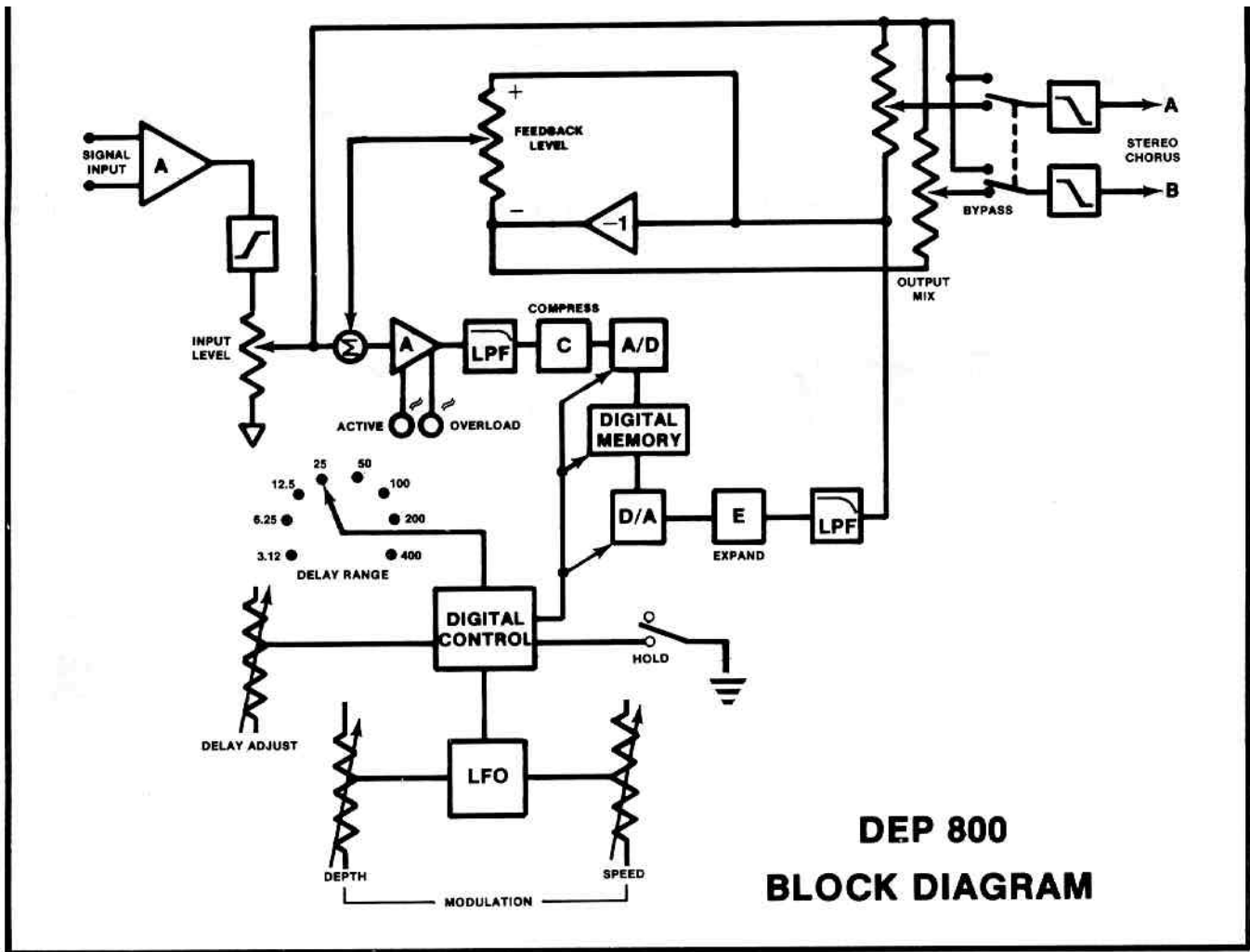

### CIRCUIT DESCRIPTION

Two separate inputs are provided on the Digital Effects Processor. An instrument level input (nominally 250 mVolts, or -12 dBV) is provided on the front panel and a line level input (nominally 2.0 Volts or +6 dBV) is provided on the rear panel. Both inputs are passed through an input gain stage in preparation for processing. If the front panel low level input jack is used the rear panel line level input jack is disconnected.

After the initial gain stage, the input signal is pre-conditioned using a pre-emphasis circuit to provide better Signal-to-Noise characteristics for effects operation.

The INPUT LEVEL control sets the level for the input signal for optimal Signal-to-Noise and ultimately the output level for the processor. The INPUT LEVEL control should be set so that the green ACTIVE indicator is lit and the red OVERLOAD indicator only flashes occasionally. Continued operation with an "OVERLOAD" condition could cause distortion and a noticeable deterioration in sound quality. It should be pointed out that the ACTIVE and OVERLOAD indicators are located after the feedback signal is mixed in, giving an excellent indication of any potential overload condition. The INPUT LEVEL control also ultimately sets the output signal level. If the green ACTIVE indicator is lit and the red OVERLOAD indicator flashes occasionally, the output level will nominally be 250 mV (-12 dBV) at the front panel output jacks and 2.0 V (+6 dBV) at the rear panel output jacks.

To minimize any problems due to aliasing, Analog-to-Digital conversion is preceded by a 10 kHz, 6-Pole, 36 dB/Octave "Chebyshev" Low Pass Filter constructed with precision components to assure flat response and minimum "in-band" ripple.

The anti-aliasing filters are followed by a compression stage to provide an increased Dynamic Range for the 8-bit Analog-to-Digital conversion. This conversion takes place at a variable rate depending on the DELAY ADJUST setting and the degree of MODULATION which is introduced as an effect. The nominal sample rate with the DELAY ADJUST set at x1 and with no MODULATION enabled is 40 kHz, once again to minimize aliasing effects should the effects be enabled. The A/D converter components are matched to assure the proper linearity and conversion accuracy for the Signal-to-Noise ratio attainable with an 8-Bit system.

The digitized signal is then stored in the memory which is constructed with the 16K Dynamic RAM (Random Access Memory) providing the 800 milliseconds of possible delay.

The Digital-to-Analog conversion is provided using state-of-the-art D/A circuitry and corrective equalization to assure no reduction in frequency response due to sampling (SIN X/X windowing).

The Digital-to-Analog conversion is followed by another 10 kHz, 6-Pole, 36 dB/Octave "Chebyshev" Low Pass Filter for signal reconstruction and "glitch" removal.

The processed analog signal is then sent to the output mix circuitry in both its in-phase and out-of-phase form so that it can be mixed with the "dry" input signal and also sent back to the input circuitry as a feedback signal. The output signals are available at the front panel low level Stereo Chorus outputs as both in-phase mixed and out-of-phase mixed signals and at the rear panel line level Stereo Chorus outputs. Both phases of the delayed signal are also available as feedback signals to either accentuate or diminish certain portions of the audio spectrum. The level of the feedback signal is controllable using the FEEDBACK LEVEL control. A 5 kHz low pass filter is available in the feedback loop to allow the reduction of high frequency noise build-up in the prolonged feedback.

The output signals are separately de-emphasized prior to the output stage in order to restore them to their original levels after processing.

Two remote controls are available on the rear panel as well as manual functions on the front panel. These controls consist of the BYPASS and HOLD controls. The BYPASS control allows the unit to be bypassed entirely, the only active control being the INPUT LEVEL control. The HOLD control allows for the infinite repetition of all the signal data in the memory without any degradation. The footswitch control connects the "tip" to the "barrel" of the phone plug to activate the remote functions.

Also available on the rear panel is an external jack input for MODULATION control. An external input can be applied through this jack to control the effects from an external source. The CONTROL VOLTAGE input should vary within a range from 0 Volts to +5 Volts, and is internally protected against transients.

The DELAY SELECT and DELAY ADJUST controls are utilized to select the range of the delay desired and the exact value of the delay or effect. The number at each setting of DELAY SELECT indicates the maximum amount of delay for that range in milliseconds (mSec). The DELAY ADJUST varies the amount of delay within that range from approximately 0.5 to 2.0 times that range setting. Thus a 4-to-1 range is available for each range setting.

The MODULATION controls are also available as front panel manual controls. The MODULATION controls consist of the MODULATION SPEED, which varies the LFO modulator frequency from 0.1 to 10.0 Hz and the MODULATION DEPTH which varies the distance through the memory that is traversed by the modulation. By adjusting the MODULATION DEPTH and the DELAY ADJUST controls, sweeps of the signal spectrum of up to 4-to-1 can be accomplished.

Due to our efforts for constant improvement, features and specifications are subject to change without notice.

<b>DANGER</b>		
EXPOSURE TO EXTREMELY HIGH NOISE LEVELS MAY CAUSE A PERMANENT HEARING LOSS. INDIVIDUALS VARY CONSIDERABLY IN SUSCEPTIBILITY TO NOISE INDUCED HEARING LOSS, BUT NEARLY EVERYONE WILL LOSE SOME HEARING IF EXPOSED TO SUFFICIENTLY INTENSE NOISE FOR A SUFFICIENT TIME.		
THE U.S. GOVERNMENT'S OCCUPATIONAL SAFETY AND HEALTH ADMINISTRATION (OSHA) HAS SPECIFIED THE FOLLOWING PERMISSIBLE NOISE LEVEL EXPOSURES:		
DURATION PER DAY IN HOURS	SOUND LEVEL dBA, SLOW RESPONSE	
8	90	
6	92	
4	95	
3	97	
2	100	
1½	102	
1	105	
½	110	
¼ or less	115	
ACCORDING TO OSHA, ANY EXPOSURE IN EXCESS OF THE ABOVE PERMISSIBLE LIMITS COULD RESULT IN SOME HEARING LOSS.		
EAR PLUGS OR PROTECTORS IN THE EAR CANALS OR OVER THE EARS MUST BE WORN WHEN OPERATING THIS AMPLIFICATION SYSTEM IN ORDER TO PREVENT A PERMANENT HEARING LOSS IF EXPOSURE IS IN EXCESS OF THE LIMITS AS SET FORTH ABOVE. TO INSURE AGAINST POTENTIALLY DANGEROUS EXPOSURE TO HIGH SOUND PRESSURE LEVELS, IT IS RECOMMENDED THAT ALL PERSONS EXPOSED TO EQUIPMENT CAPABLE OF PRODUCING HIGH SOUND PRESSURE LEVELS SUCH AS THIS AMPLIFICATION SYSTEM BE PROTECTED BY HEARING PROTECTORS WHILE THIS UNIT IS IN OPERATION.		
<b>CAUTION</b>		
THIS MIXING CONSOLE/PREAMP/EFFECTS DEVICE HAS BEEN DESIGNED AND CONSTRUCTED TO PROVIDE ADEQUATE SIGNAL (VOLTAGE) FOR PLAYING MODERN MUSIC. IMPROPER USE OF THE GAIN/EQUALIZATION CONTROLS AND/OR IMPROPER USE OF INTERNAL/EXTERNAL BUSES MAY CREATE CLIPPING (SQUARE WAVES) AND POSSIBLY CAUSE SUBSEQUENT DAMAGE TO THE LOUDSPEAKER SYSTEMS. EXTENDED OPERATION OF THE GAIN/EQUALIZATION CONTROLS IN THEIR MAXIMUM POSITIONS IS, THEREFORE, NOT RECOMMENDED. PLEASE BE AWARE THAT MAXIMUM POWER CAN BE OBTAINED WITH VERY LOW SETTINGS OF THE GAIN/EQUALIZATION CONTROLS IF THE INPUT SIGNAL IS VERY STRONG.		
IT IS COMMON PRACTICE AMONG USERS OF SOUND REINFORCEMENT EQUIPMENT TO IDENTIFY THE INDIVIDUAL CHANNELS WITH A STRIP OF TAPE PLACED ABOVE OR BELOW THE ROW OF VOLUME FADERS. MANY TYPES OR BRANDS OF TAPE HAVE A VERY STRONG ADHESIVE WHICH CAN INHIBIT THE PAINT ON THE FACEPLATE AND ACTUALLY REMOVE THE PAINT WHEN THE TAPE IS REMOVED. WE STRONGLY RECOMMEND THAT SCOTCH TAPE NOT BE USED ON PAINTED SURFACES NOR ANY OTHER TAPE THAT IS NOT ESPECIALLY DESIGNED FOR SUCH APPLICATIONS. MEDIUM OR LIGHT ADHESIVE MASKING OR MIXER LABEL TAPE IS RECOMMENDED IF TAPE IS USED. ANY TAPE LEFT ON PAINTED SURFACE FOR EXTENDED PERIODS WILL BE DIFFICULT TO REMOVE. NEVER USE CLEAR OR SCOTCH TAPE FOR THESE APPLICATIONS.		
1. Read all safety and operating instructions before using this product.	8. Connect only to a power supply of the type marked on the unit adjacent to the power supply cord.	13. Care should be taken so that objects do not fall and liquids are not spilled into the unit through the ventilation holes or any other openings.
2. All safety and operating instructions should be retained for future reference.	9. Never break off the ground pin on the power supply cord. For more information on grounding write for our free booklet "Shock Hazard and Grounding."	14. This unit should be checked by a qualified service technician if:
3. Obey all cautions in the operating instructions and on the back of the unit.	10. Power supply cords should always be handled carefully. Never walk or place equipment on power supply cords. Periodically check cords for cuts or signs of stress especially at the plug and the point where the cord exits the unit.	A. The power supply cord or plug has been damaged.
4. All operating instructions should be followed.	11. The power supply cord should be unplugged when the unit is to be unused for long periods of time.	B. Anything has fallen or been spilled into the unit.
5. This product should not be used near water, i.e. a bathtub, sink, swimming pool, wet basement, etc.	12. Metal parts can be cleaned with a damp rag. The vinyl covering used on some units can be cleaned with a damp rag, or an ammonia based household cleaner if necessary.	C. The unit does not operate correctly.
6. This product should be located so that its position does not interfere with its proper ventilation. It should not be placed flat against a wall or placed in a built-in enclosure that will impede the flow of cooling air.		D. The unit has been dropped or the enclosure damaged.
7. This product should not be placed near a source of heat such as a stove, heater, radiator or another heat producing amplifier.		15. The user should not attempt to service this equipment. All service work should be done by a qualified service technician.